

SIA

Built-in Combi Microwave Oven

INSTRUCTION MANUAL

MODEL: **BICM25**



**Please read these instructions carefully before using
your microwave oven.**

PRECAUTIONS TO AVOID POSSIBLE EXPOSURE TO EXCESSIVE MICROWAVE ENERGY

- (a) Do not attempt to operate this oven with the door open since this can result in harmful exposure to microwave energy. It is important not to break or tamper with the safety interlocks.
- (b) Do not place any object between the oven front face and the door or allow soil or cleaner residue to accumulate on sealing surfaces.
- (c) **WARNING:** If the door or door seals are damaged, the oven must not be operated until it has been repaired by a competent person.

ADDENDUM

If the apparatus is not maintained in a good state of cleanliness, its surface could be degraded and affect the lifespan of the apparatus and lead to a dangerous situation.

Specifications

Model:	BICM25
Rated Voltage:	240V~/50Hz
Rated Input Power(Microwave):	1450W
Rated Output Power(Microwave):	1260W
Rated Input Power(Grill):	2450W
Oven Capacity:	25L
External Dimensions:	595x421x386mm

The appliances are not intended to be operated by means of an external timer or separate remote-control system.

This appliance is intended to be used in household and similar applications such as:

- staff kitchen areas in shops, offices and other working environments;
- farm houses;
- by clients in hotels, motels and other residential type environments;
- bed and breakfast type environments.

IMPORTANT SAFETY INSTRUCTIONS

WARNING

To reduce the risk of fire, electric shock, injury to persons or exposure to excessive microwave oven energy when using your appliance, follow basic precautions, including the following:

1. **Warning:** Liquids and other foods must not be heated in sealed containers since they are liable to explode.
2. **Warning:** It is hazardous for anyone other than a competent person to carry out any service or repair operation that involves the removal of a cover which gives protection against exposure to microwave energy.
3. **Warning:** Only allow children to use the oven without supervision when adequate instructions have been given so that the child is able to use the oven in a safe way and understand the hazards of improper use.
4. **Warning:** When the appliance is operated in the combination mode, children should only use the oven under adult supervision due to the temperatures generated.
(only for grill series)
5. Only use utensils suitable for use in microwave ovens.
6. The oven should be cleaned regularly and any food deposits should be removed.
7. Read and follow the specific: "PRECAUTIONS TO AVOID POSSIBLE EXPOSURE TO EXCESSIVE MICROWAVE ENERGY".
8. When heating food in plastic or paper containers, keep an eye on the oven due to the possibility of ignition.
9. If smoke is observed, switch off or unplug the appliance and keep the door closed in order to stifle any flames.
10. Do not overcook food.
11. Do not use the oven cavity for storage purposes. Do not store items, such as bread, cookies, etc. inside the oven.
12. Remove wire twist-ties and metal handles from paper or plastic containers/bags before placing them in the oven.
13. Install or locate this oven only in accordance with the installation instructions provided.
14. Eggs in the shell and whole hard-boiled eggs should not be heated in microwave ovens since they may explode, even after microwave heating has ended.
15. Use this appliance only for its intended uses as described in manual. Do not use corrosive chemicals or vapors in this appliance. This oven is especially designed to heat. It is not designed for industrial or laboratory use.
16. If the supply cord is damaged, it must be replaced by the manufacturer, its service agent or similarly qualified persons in order to avoid a hazard.
17. Do not store or use this appliance outdoors.

18. Do not use this oven near water, in a wet basement or near a swimming pool.
19. The temperature of accessible surfaces may be high when the appliance is operating. Keep cord away from heated surface, and do not cover any vents on the oven.
20. Do not let cord hang over edge of table or counter.
21. Failure to maintain the oven in a clean condition could lead to deterioration of the surface that could adversely affect the life of the appliance and possibly result in a hazardous situation.
22. The contents of feeding bottles and baby food jars shall be stirred or shaken and the temperature checked before consumption, in order to avoid burns.
23. Microwave heating of beverages can result in delayed eruptive boiling, therefore take care when handling the container.
24. The appliance is not intended for use by persons (including children) with reduced physical, sensory or mental capabilities, or lack of experience and knowledge, unless they have been given supervision or instruction concerning use of the appliance by a person responsible for their safety. (for market beyond European market)
25. Children should be supervised to ensure that they do not play with the appliance. This appliance can be used by children aged from 8 years and above and persons with reduced physical, sensory or mental capabilities or lack of experience and knowledge if they have been given supervision or instruction concerning use of the appliance in a safe way and understand the hazards involved. Children shall not play with the appliance. Cleaning and user maintenance shall not be made by children without supervision. (for European market.)
26. The microwave oven shall not be placed in a cabinet.
27. The microwave oven is intended for heating food and beverages. Drying of food or clothing and heating of warming pads, slippers, sponges, damp cloth and similar may lead to risk of injury, ignition or fire. Don't immerse the appliance in water or other liquid when cleaning. The appliance shall not be cleaned with a steam cleaner.
28. Metallic containers for food and beverages are not allowed during microwave cooking.
29. Care should be taken not to displace the turntable when removing containers from the appliance.
30. The appliance must not be installed behind a decorative door in order to avoid overheating.
31. Important safety instructions read carefully and keep for future reference.

To Reduce the Risk of Injury to Persons

Grounding Installation

DANGER

Electric Shock Hazard
Touching some of the internal components can cause serious personal injury or death. Do not disassemble this appliance.

WARNING

Electric Shock Hazard
Improper use of the grounding can result in electric shock. Do not plug into an outlet until appliance is properly installed and grounded.

CLEANING

Be sure to disconnect the oven from the power supply.

1. Clean the inside of the oven after using with a slightly damp cloth.
2. Clean the accessories in the usual way in soapy water.
3. The door frame and seal and neighbouring parts must be cleaned carefully with a damp cloth when they are dirty.

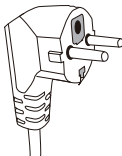

This appliance must be grounded. In the event of an electrical short circuit, grounding reduces the risk of electric shock by providing an escape wire for the electric current. This appliance is equipped with a cord having a grounding wire with a grounding plug. The plug must be plugged into an outlet that is properly installed and grounded.

Consult a qualified electrician or serviceman if the grounding instructions are not completely understood or if doubt exists as to whether the appliance is properly grounded. If it is necessary to use an extension cord, use only a 3-wire extension cord.

1. A short power-supply cord is provided to reduce the risks resulting from becoming entangled in or tripping over a longer cord.
2. If a long cord set or extension cord is used:
 - 1)The marked electrical rating of the cord set or extension cord should be at least as great as the electrical rating of the appliance.
 - 2)The extension cord must be a grounding-type 3-wire cord.
 - 3)The long cord should be arranged so that it will not drape over the counter top or tabletop where it can be pulled on by children or tripped over unintentionally.

UTENSILS

CAUTION

Personal Injury Hazard

It is hazardous for anyone other than a competent person to carry out any service or repair operation that involves the removal of a cover which gives protection against exposure to microwave energy.

See the instructions on "Materials you can use in microwave oven or to be avoided in microwave oven."

There may be certain non-metallic utensils that are not safe to use for microwaving. If in doubt, you can test the utensil in question following the procedure below.

Utensil Test:

1. Fill a microwave-safe container with 1 cup of cold water (250ml) along with the utensil in question.
2. Cook on maximum power for 1 minute.
3. Carefully feel the utensil. If the empty utensil is warm, do not use it for microwave cooking.

Materials you can use in microwave oven

Utensils Remarks

Aluminum foil	Shielding only. Small smooth pieces can be used to cover thin parts of meat or poultry to prevent overcooking. Arcing can occur if foil is too close to oven walls. The foil should be at least 1 inch (2.5cm) away from oven walls.
Browning dish	Follow manufacturer's instructions. The bottom of browning dish must be at least 3/16 inch (5mm) above the turntable. Incorrect usage may cause the turntable to break.
Dinnerware	Microwave-safe only. Follow manufacturer's instructions. Do not use cracked or chipped dishes.
Glass jars	Always remove lid. Use only to heat food until just warm. Most glass jars are not heat resistant and may break.
Glassware	Heat-resistant oven glassware only. Make sure there is no metallic trim. Do not use cracked or chipped dishes.
Oven cooking bags	Follow manufacturer's instructions. Do not close with metal tie. Make slits to allow steam to escape.
Paper plates and cups	Use for short-term cooking/warming only. Do not leave oven unattended while cooking.
Paper towels	Use to cover food for reheating and absorbing fat. Use with supervision for a short-term cooking only.
Parchment paper	Use as a cover to prevent splattering or a wrap for steaming.
Plastic	Microwave-safe only. Follow the manufacturer's instructions. Should be labeled "Microwave Safe". Some plastic containers soften, as the food inside gets hot. "Boiling bags" and tightly closed plastic bags should be slit, pierced or vented as directed by package.
Plastic wrap	Microwave-safe only. Use to cover food during cooking to retain moisture. Do not allow plastic wrap to touch food.
Thermometers	Microwave-safe only (meat and candy thermometers).
Wax paper	Use as a cover to prevent splattering and retain moisture.

Materials to be avoided in microwave oven

Utensils Remarks

Aluminum tray	May cause arcing. Transfer food into microwave-safe dish.
Food carton with metal handle	May cause arcing. Transfer food into microwave-safe dish.
Metal or metal-trimmed utensils	Metal shields the food from microwave energy. Metal trim may cause arcing.
Metal twist ties	May cause arcing and could cause a fire in the oven.
Paper bags	May cause a fire in the oven.
Plastic foam	Plastic foam may melt or contaminate the liquid inside when exposed to high temperature.
Wood	Wood will dry out when used in the microwave oven and may split or crack.

SETTING UP YOUR OVEN

Names of Oven Parts and Accessories

Remove the oven and all materials from the carton and oven cavity.

Your oven comes with the following accessories:

Glass tray	1
Turntable ring assembly	1
Instruction Manual	1

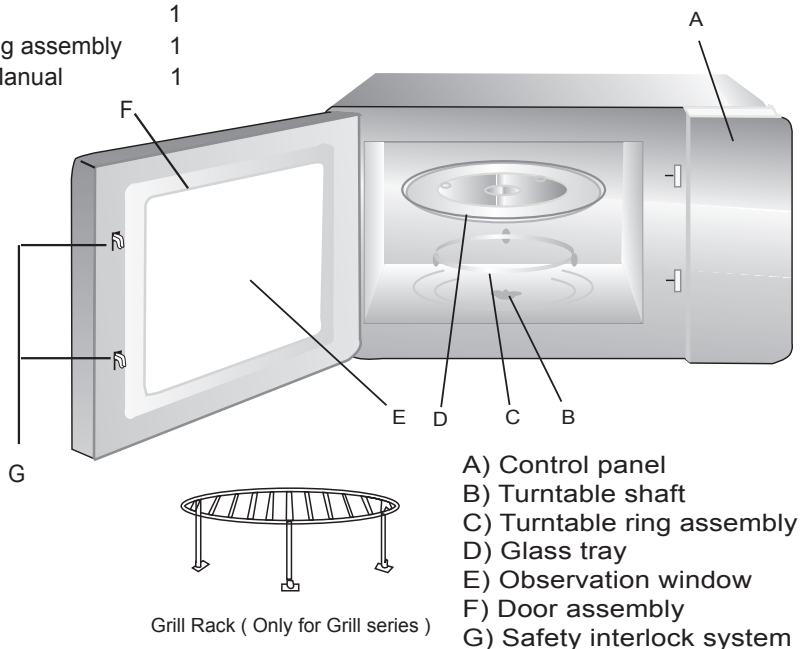

Shut off oven power if the door is opened during operation.

Turntable Installation

Hub (underside)

Glass tray

Turntable shaft



Turntable ring assembly

- a. Never place the glass tray upside down. The glass tray should never be restricted.
- b. Both glass tray and turntable ring assembly must always be used during cooking.
- c. All food and containers of food are always placed on the glass tray for cooking.
- d. If glass tray or turntable ring assembly cracks or breaks, contact your nearest authorized service center.

Installation

1. Remove any protective film found on the microwave oven cabinet surface, do not remove the light white Mica cover that is attached to the oven cavity to protect the magnetron.
2. This oven is intended for built-in use only. It is not intended for counter-top use or for use inside a cupboard.
3. The appliance can be installed in a 60cm wide wall-mounted cupboard(at least 55cm deep).
- 4.The appliance is fitted with a plug and must only be connected to a properly installed earthed socket.
- 5.The mains voltage must correspond to the voltage specified on the rating plate.
- 6.The socket must be installed and connecting cable must only be replaced by a qualified electrician.If the plug is no longer to accessible following installation,an all-pole disconnecting device must be present on the installation side with a contact gap of at lease 3mm.
- 7.Adapters,multi-way strips and extension leads must not be used. Overloading can result in a risk of fire.

Installation drawing

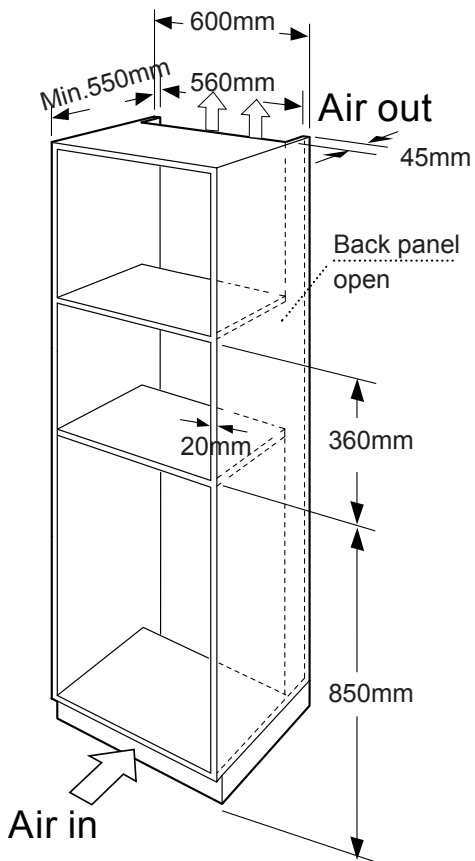

Step 1

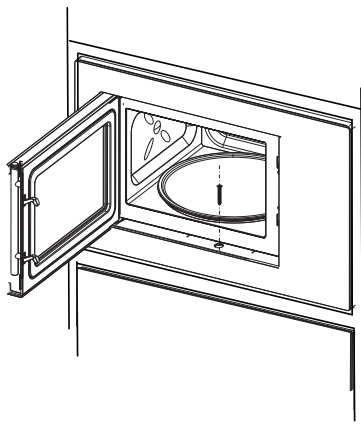

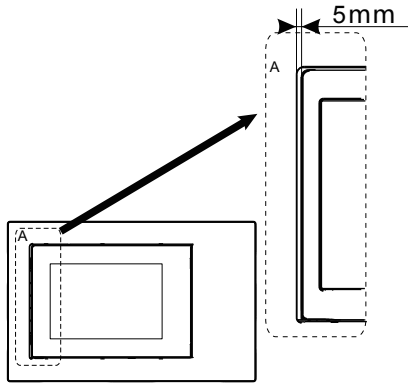

Warning for Installation:

While installing the product, please ensure to keep the width of Gap A more than 5mm, in order to have a smooth opening for the end-user's usage.

Operation Instructions

1. Clock Setting

When the microwave oven is electrified, the LED will display "0:00", buzzer will ring once.

1) Press "  " twice, the hour figures will flash.

2) Turn "  " to adjust the hour figures, the input time should be within 0--23.



3) Press "  ", the minute figures will flash.





4) Turn "  " to adjust the minute figures, the input time should be within 0--59.

5) Press "  " to finish clock setting. ":" will flash, and the time will light.





Note: 1) If the clock is not set, it would not function when powered.

2. Microwave Cooking

Press "  " the LED will display " 900 ". Press  to choose the power you want, and " 900 ", "800 "、 ... "100 " will display for each.

Then press  or  or "  " to set cooking time from 0:05 to 95:00. Press "  " again to start cooking.

1) Press "  " once, the screen display "P100".



2) Press "  " to choose P80 microwave power. press  or  or "  " "

3) Turn "  " to adjust the cooking time until the oven displays "20:00".

4) Press "  " to start cooking .

Note: the step quantities for the adjustment time of the coding switch are as follow:

0---1 min	:	5 seconds
1---5 min	:	10 seconds
5---10 min	:	30 seconds
10---30 min	:	1 minute
30---95 min	:	5 minutes

Note:  can enter the time setting,  can enter the microwave gear setting, and press  to cycle through time gear time set up.



"Microwave" Pad instructions



Order	Display	Microwave Power
1	P100	100%
2	P80	80%
3	P50	50%
4	P30	30%
5	P10	10%



3. Grill or Combi. Cooking

Press "", the LED will display "130 °C (cannot be changed);

to set cooking time from 0:05 to 95:00. Press "" to start cooking.

Press "", the LED will display "C-1", Then turn "" the LED will display "C-2",

press " or " or "" to confirmation function.

Then turn "" to set cooking time from 0:05 to 95:00. Press "" to start cooking.

"Convection/Grill/Combi." Pad instructions



Combine the cooking parts.	C1 Microwave plus grill	C2 Microwave plus hot wind
Microwave heating time	18" (60%)	18" (60%)
Barbecue time	12" (40%)	/
Hot air heating time.	/	12" (40%)
Fan motor	all-pass	all-pass
Dc motor	all-pass	all-pass
The heating cycle	30"	30"





Note: Pressing " under function " can return to the gear setting.



Note: If half of the grill time passes, the oven sounds, and this is normal.



In order to have a better effect of grilling food, you should turn the food over, close the door, and then if no operation the oven will continue cooking.

4. Convection cooking

Press "", the LED will display "180", turn "" to choose the power you want,

1) If no preheating, then press  or  or "" to set the cooking time from 0:05-95:00, press  to start cooking.

2) If preheating, press  to enter preheating mode. When the preheating temperature is reached, the buzzer will prompt, put the food in and close the oven door. then turn "" to set the cooking time, press  to start cooking.

Notice: 1. Real time temperature display during temperature rise "" twinkle.
Set temperature reached "" bright.

2. When the preheating mode reaches the set temperature, if there is no door opening action for 10 minutes, the heating will be stopped automatically, and the buzzer will return to the standby state.





5. Quick Start

1) In waiting state, Press  to start cooking with 100% power, each added press will increase 30 seconds cooking time up to 95 minutes.

2) In microwave, grill, combi. cooking or time defrost state, each press of  can increase 30 seconds of cooking time.

3) In waiting state, turn "" anti-clockwise to set cooking time with 100% microwave power, then press  to start cooking.





6. Defrost By Weight

1) Press "" and the oven will display "dEF1". press  or  or "" enter weight setting.

2) Turn "" to select the weight of food from 100 to 2000 g.

3) Press  to start defrosting.

7. Defrost By Time

1) Press "" twice, and the oven will display "dEF1". press  or  or "" enter time setting.

2) Turn "" to select the defrost time.

3) Press "" to start defrosting.





8. Menu

1) Press "  " to choose the menu, and " P1 " to " P 8 " will display, which means cake, pizza, soup, chicken meat, pasta, vegetable, potato and reheat.

2) Turn "  " to choose the default weight as the menu chart.

3) Press "  " to start cooking.

Example: If you want to use "Menu" to cook vegetable for 400g.

1) Press "  " then  to "P 6" display. press  or  "enter weight setting.

2) Turn "  " to select the weight of vegetable till "400" display.

3) Press "  " to start cooking.

The menu chart:

Menu	Weight	Display
P1 Cake	500 g	500 g
P2 Pizza	200 g	200 g
	400 g	400 g
P3 Soup	200 g	200 g
	400 g	400 g
	600 g	600 g
P4 Chicken meat	1000 g	1000 g
P5 Pasta	50+450 g	50 g
	100+800 g	100 g
	150+1200 g	150 g
P6 Vegetable	200 g	200 g
	400 g	400 g
	600 g	600 g
P7 Potato	250 g	250 g
	500 g	500 g
	750 g	750 g
P8 Reheat	200 g	200 g
	400 g	400 g
	600 g	600 g

Note: The cooking time is displayed after the automatic menu cooking starts.

1. Non-preheating such as Pizza 200g cooking time shows 7'30', time decreases until the end of cooking.
2. Preheat as Cake cooking shows 150 preheat, buzzer B-B alerts users to put food in microwave oven twice after 150 preheat, after which time continues to decrease from 40' until the end of cooking.
3. Time error should not exceed 1 second when switching fire.

9. Timer

1) Press "  " once, and the LED will display " 0:00 ".

2) Set timer. (Consult the instruction of clock setting.)

3) Press "  " to start the timer.

4) The buzzer will ring when the time count down.



10. Inquiring Function

1) In cooking state, press "  ", the current time will be displayed 3 seconds.

2) In states of microwave, press "  " the current power will be displayed 3 seconds.

3) In states of grill and combination cooking, press "  " the current menu will be displayed 3 seconds.

11. Lock-out Function for Children

Lock: In waiting state, press "  " for 2 seconds, there will be a long beep denoting entering the children-lock state and the locked indicator will display if the time has been set, otherwise, the LED will display "  ".

Lock quitting: In locked state, press "  " for 3 seconds, there will be a long "beep" denoting that the lock is released.

Trouble shooting

Normal	
Microwave oven interfering TV reception	Radio and TV reception may be interfered when microwave oven operating. It is similar to the interference of small electrical appliances, like mixer, vacuum cleaner, and electric fan. It is normal.
Dim oven light	In low power microwave cooking, oven light may become dim. It is normal.
Steam accumulating on door, hot air out of vents	In cooking, steam may come out of food. Most will get out from vents. But some may accumulate on cool place like oven door. It is normal.
Oven started accidentally with no food in.	It is forbidden to run the unit without any food inside. It is very dangerous.

Trouble	Possible Cause	Remedy
Oven can not be started.	(1) Power cord not plugged in tightly.	Unplug. Then plug again after 10 seconds.
	(2) Fuse blowing or circuit breaker works.	Replace fuse or reset circuit breaker (repaired by professional personnel of our company)
	(3) Trouble with outlet.	Test outlet with other electrical appliances.
Oven does not heat.	(4) Door not closed well.	Close door well.
Glass turntable makes noise when microwave oven operates	(5) Dirty roller rest and oven bottom.	Refer to "Maintenance of Microwave" to clean dirty parts.

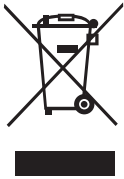

According to Waste of Electrical and Electronic Equipment (WEEE) directive, WEEE should be separately collected and treated. If at any time in future you need to dispose of this product please do NOT dispose of this product with household waste. Please send this product to WEEE collecting points where available.



The accessible surface may be hot during operation.



Service Contact Number:

Tel: **01623 625658**

SIA Appliances Ltd, Unit A, Concorde Way, Millennium Business Park,
Mansfield, Nottinghamshire, NG19 7JZ